

Stavebnice – výpravní budova Krimml

Stavební návod pro složení stavebnice

Doporučujeme Vám si nejdříve projít tento návod a poté si rozmyslet, zdali se budete držet návodu, nebo zvolíte vlastní pořadí navazujících kroků, protože každý modelář může mít trochu jiné zvyklosti při stavbě modelů. Před začátkem kompletace doporučujeme mít díly již nabarvené.

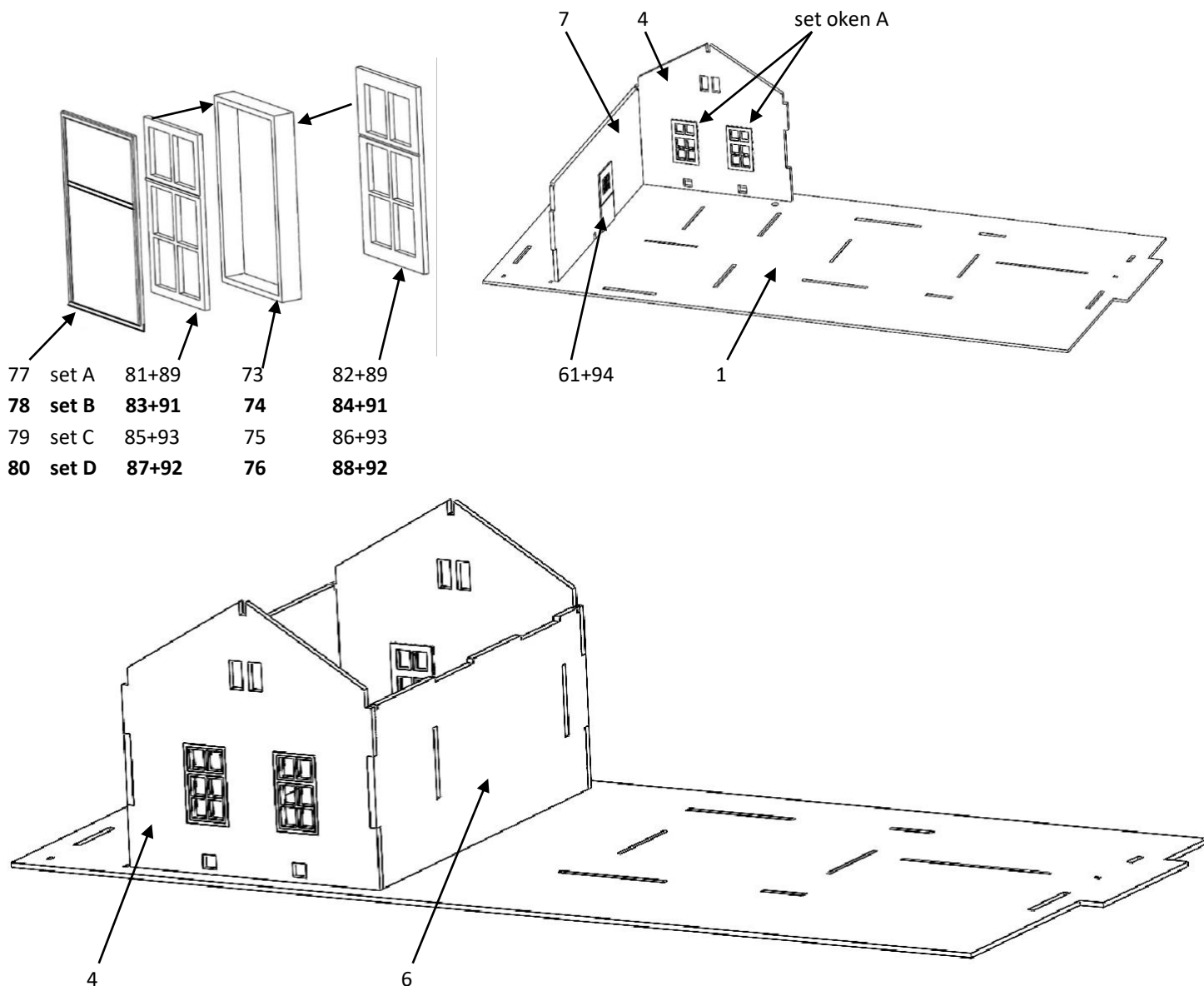

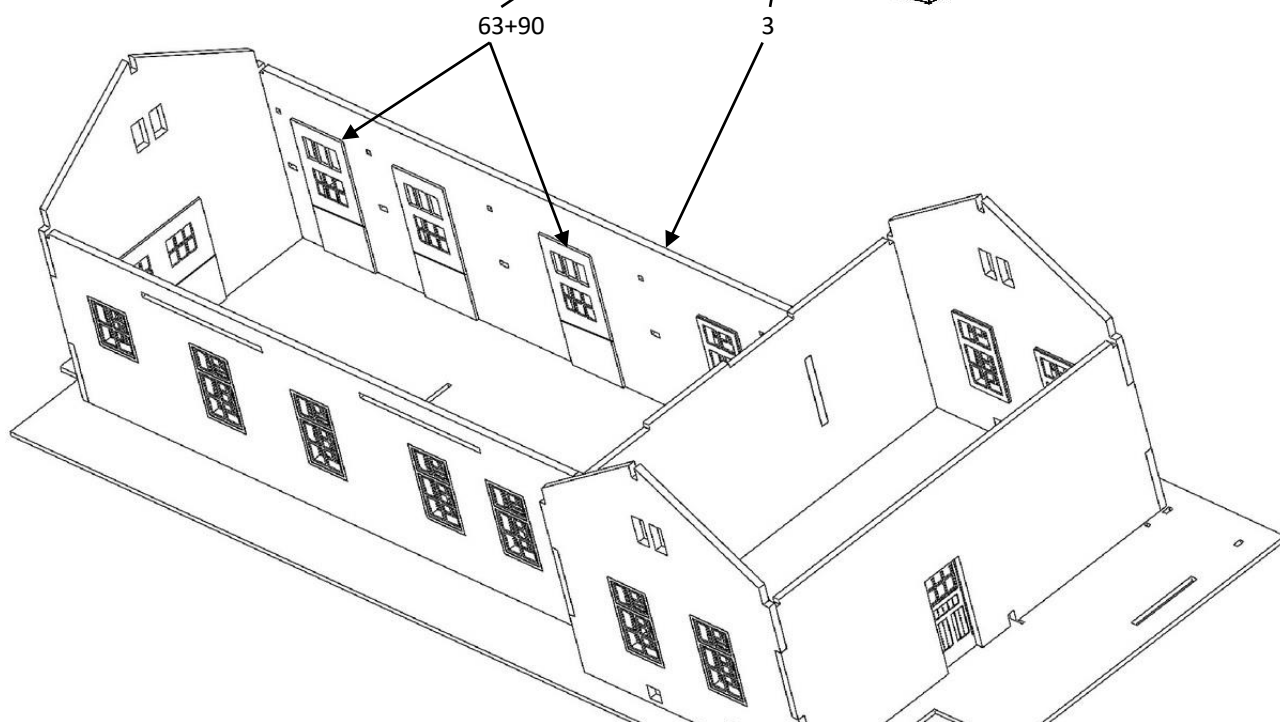
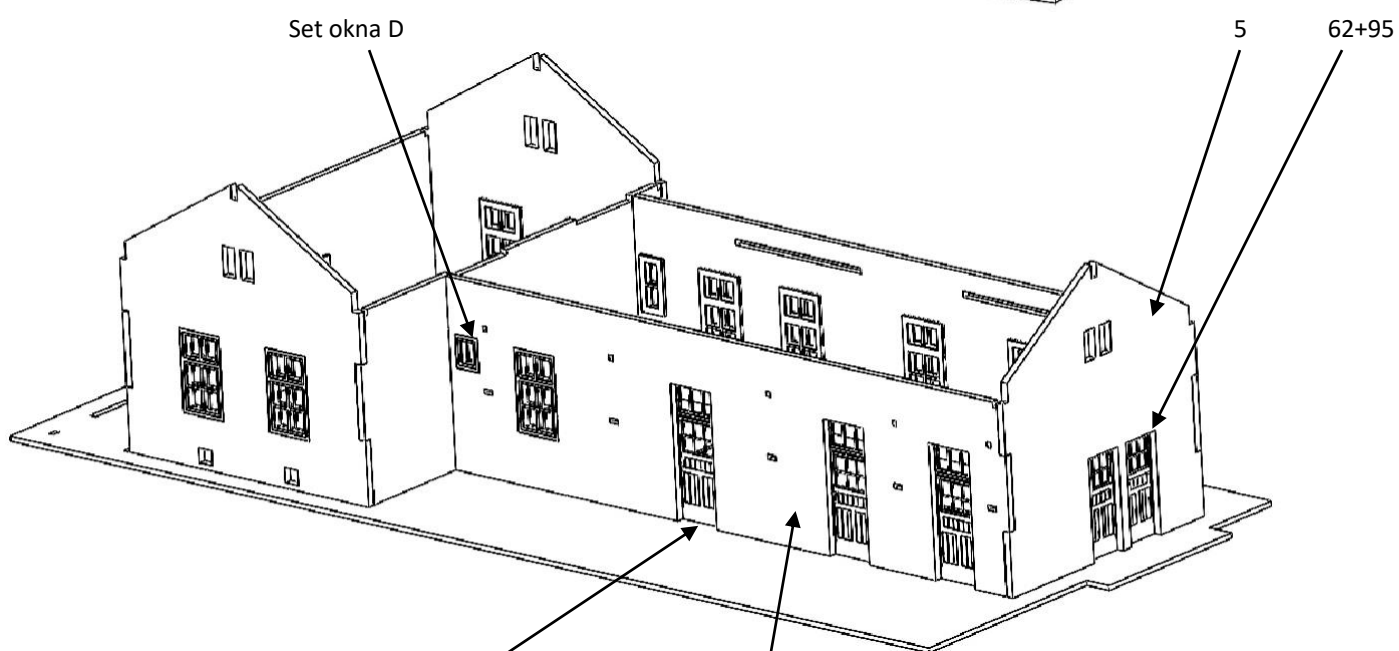
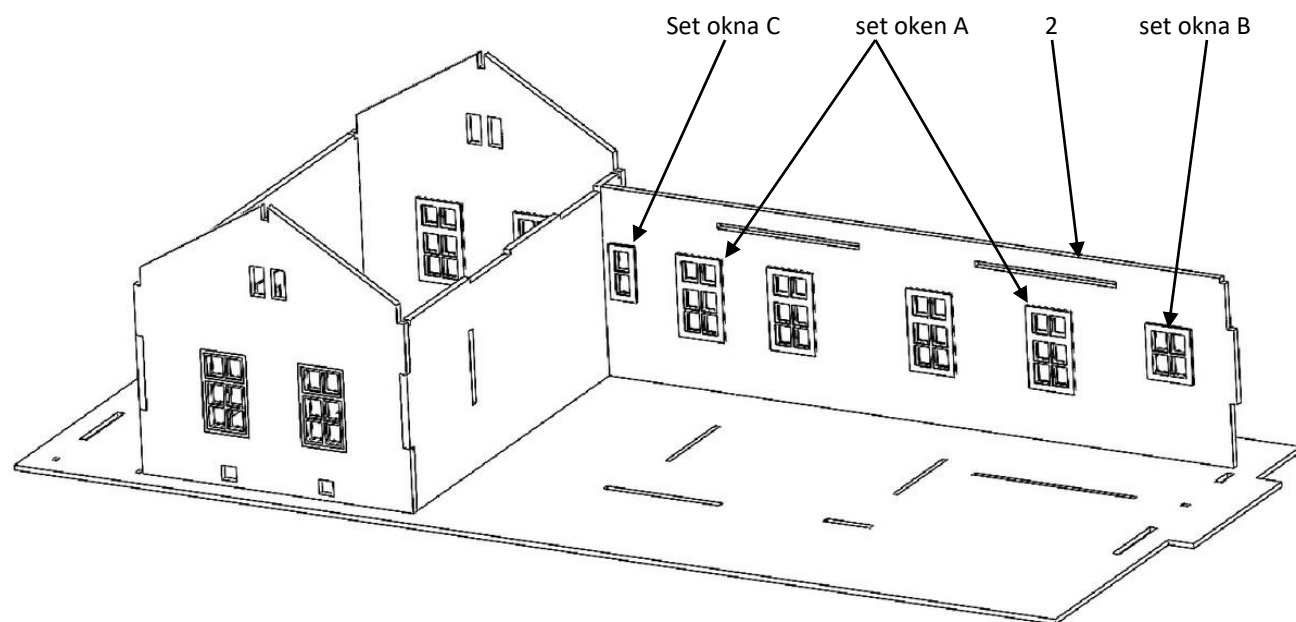

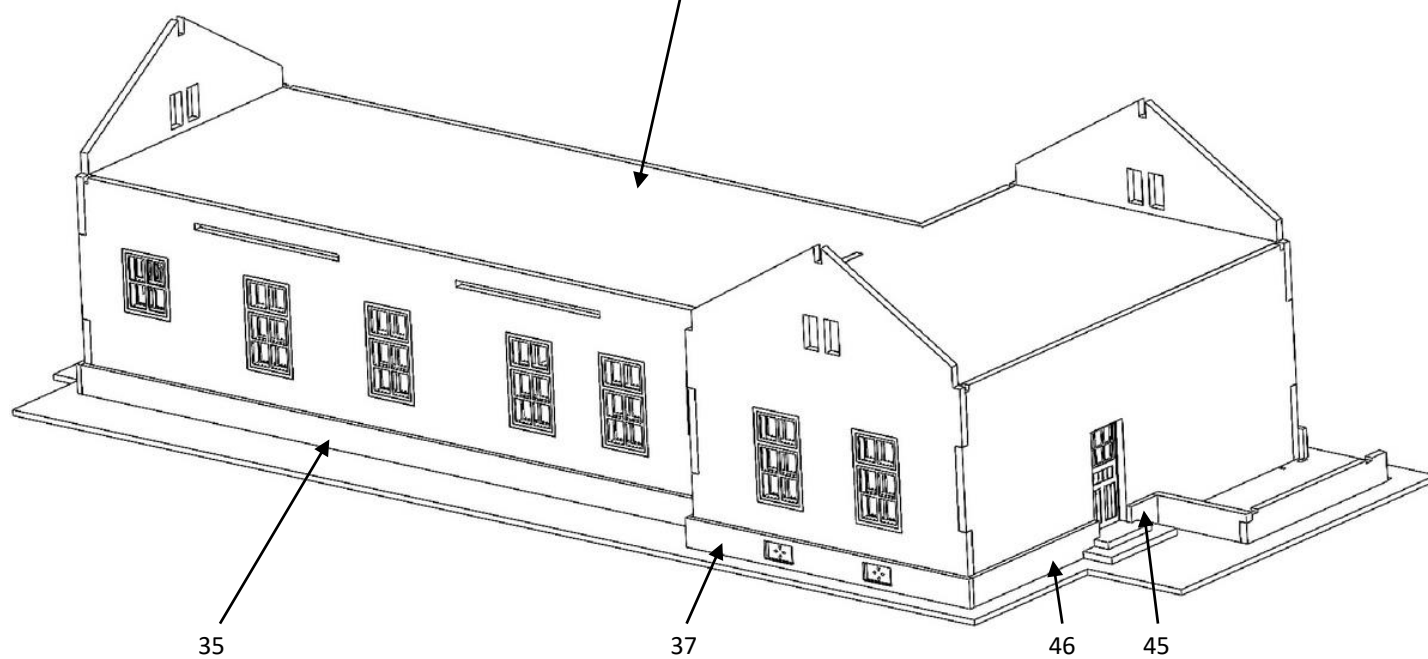
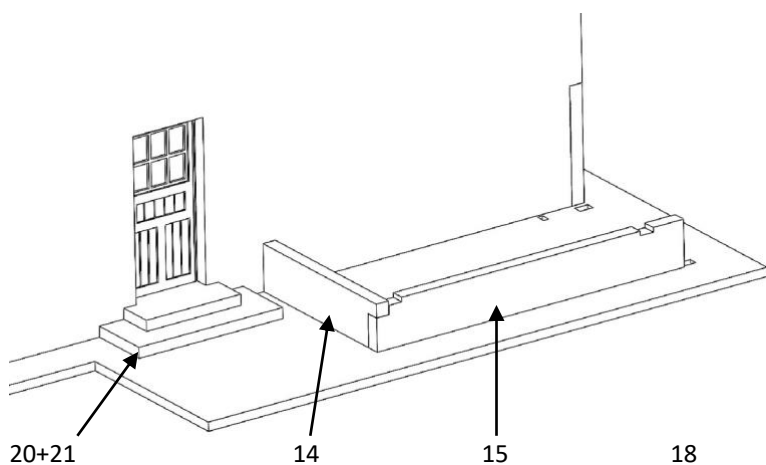
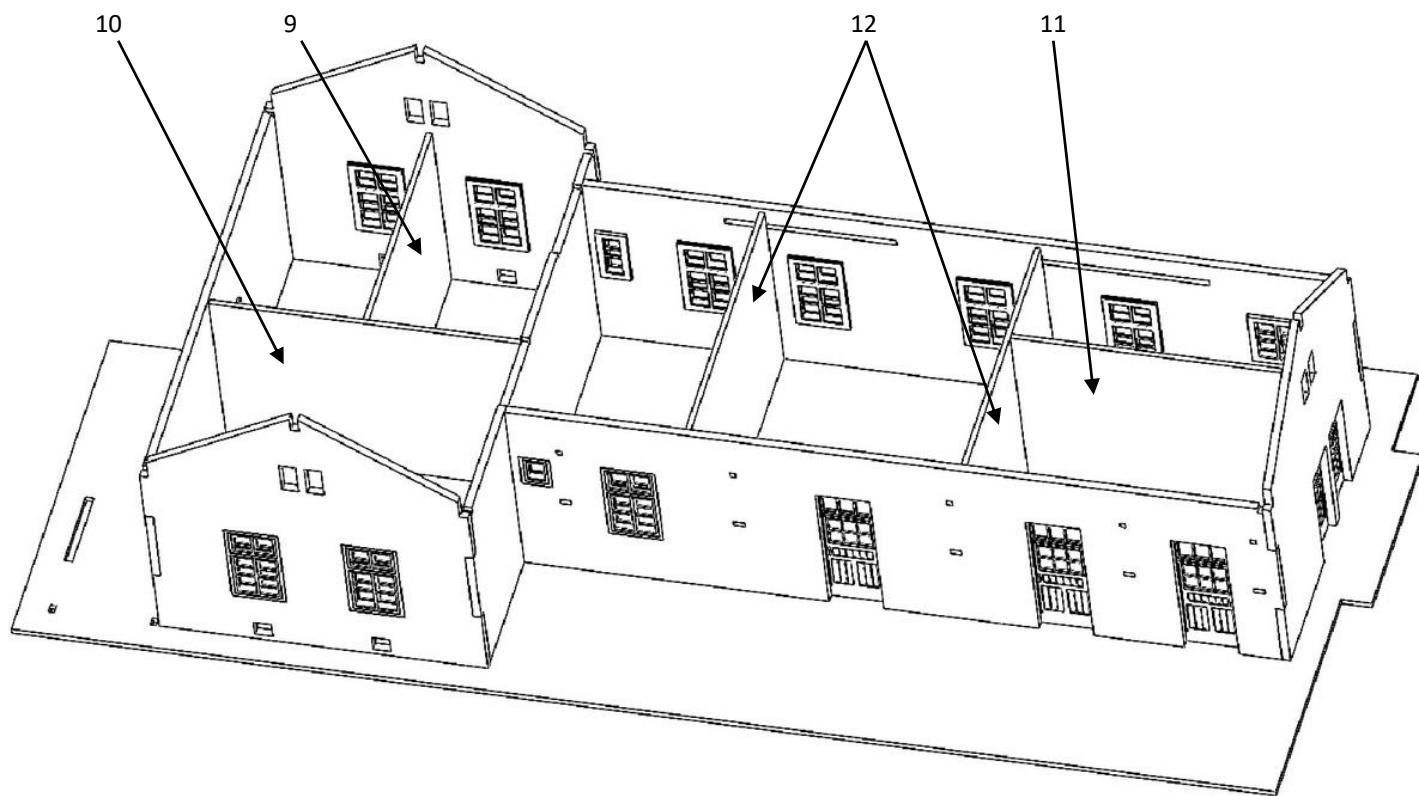

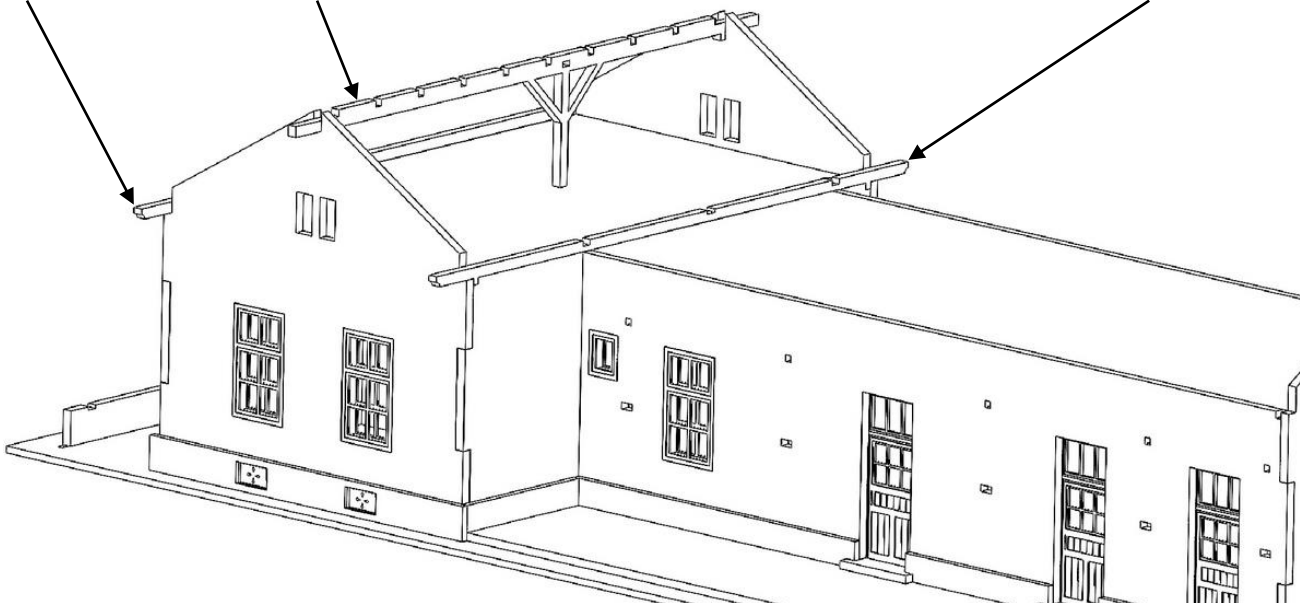
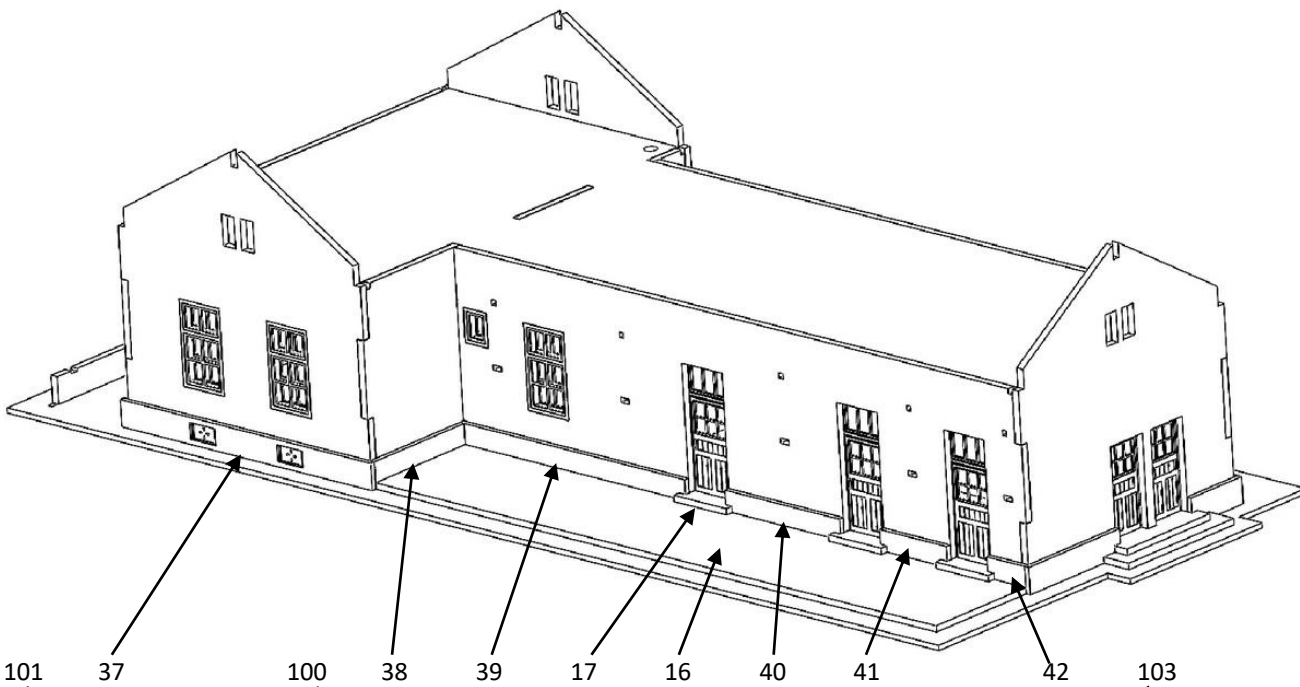
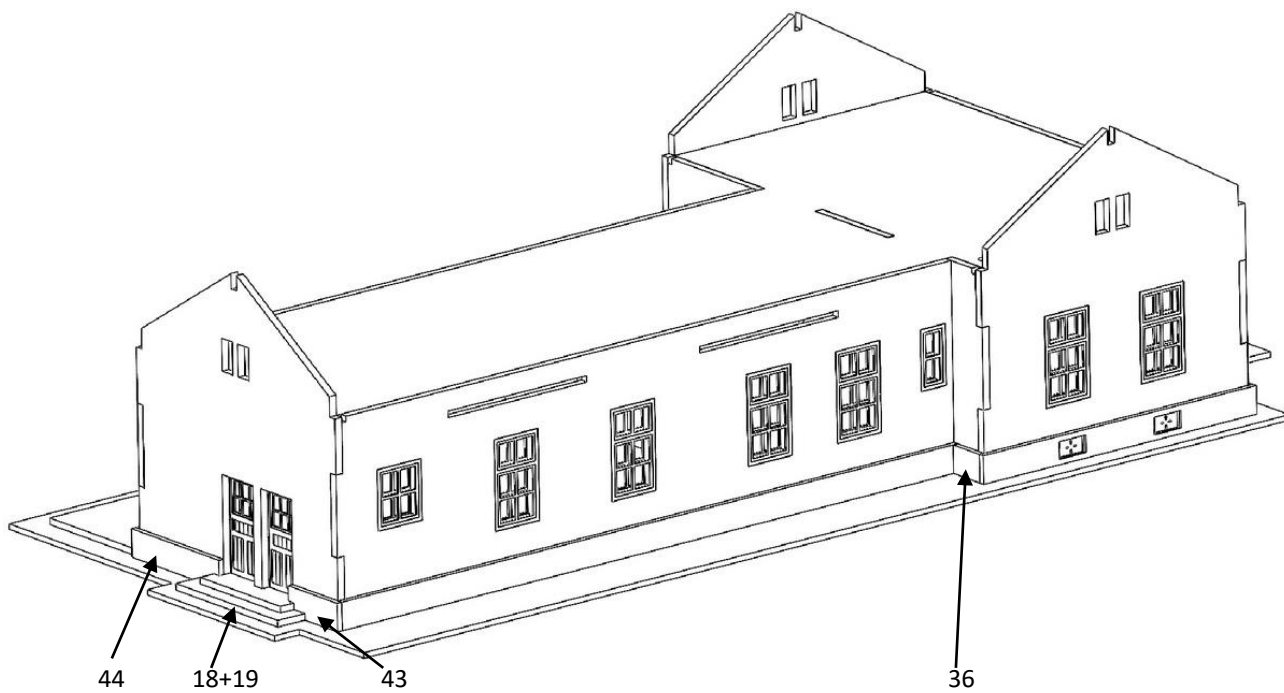

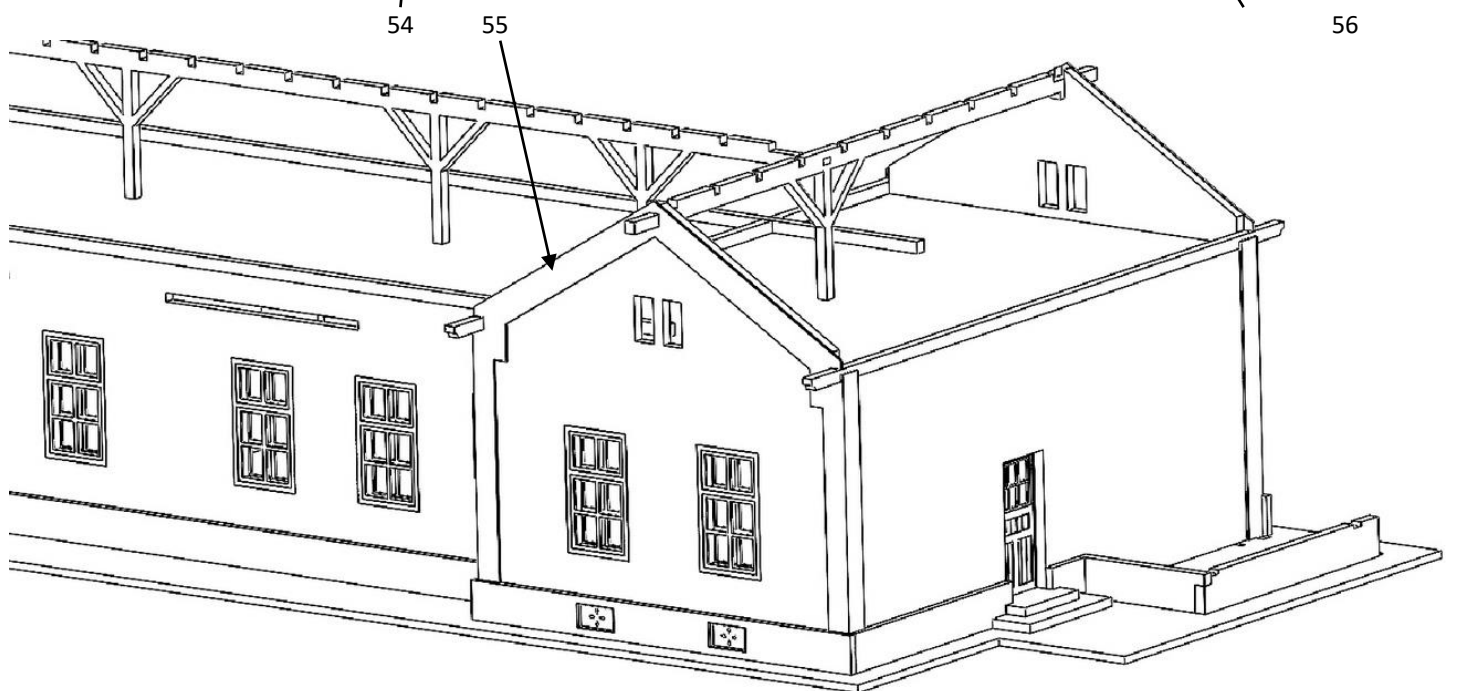
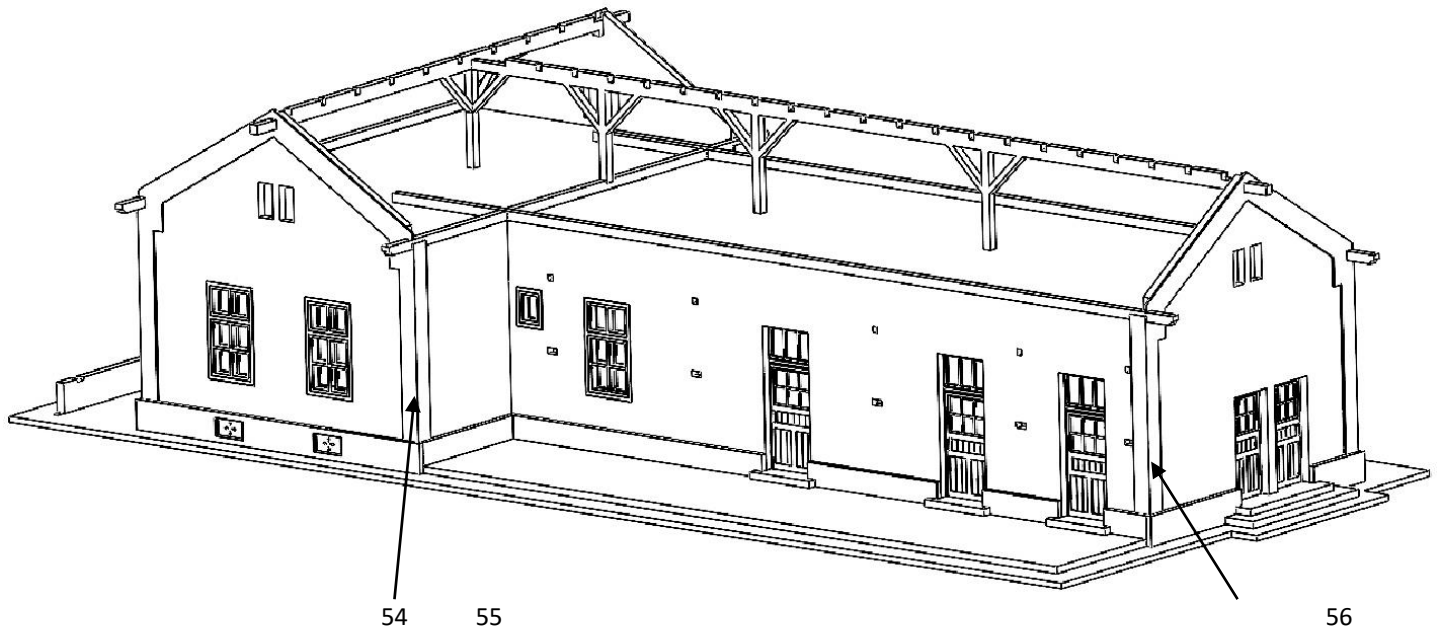
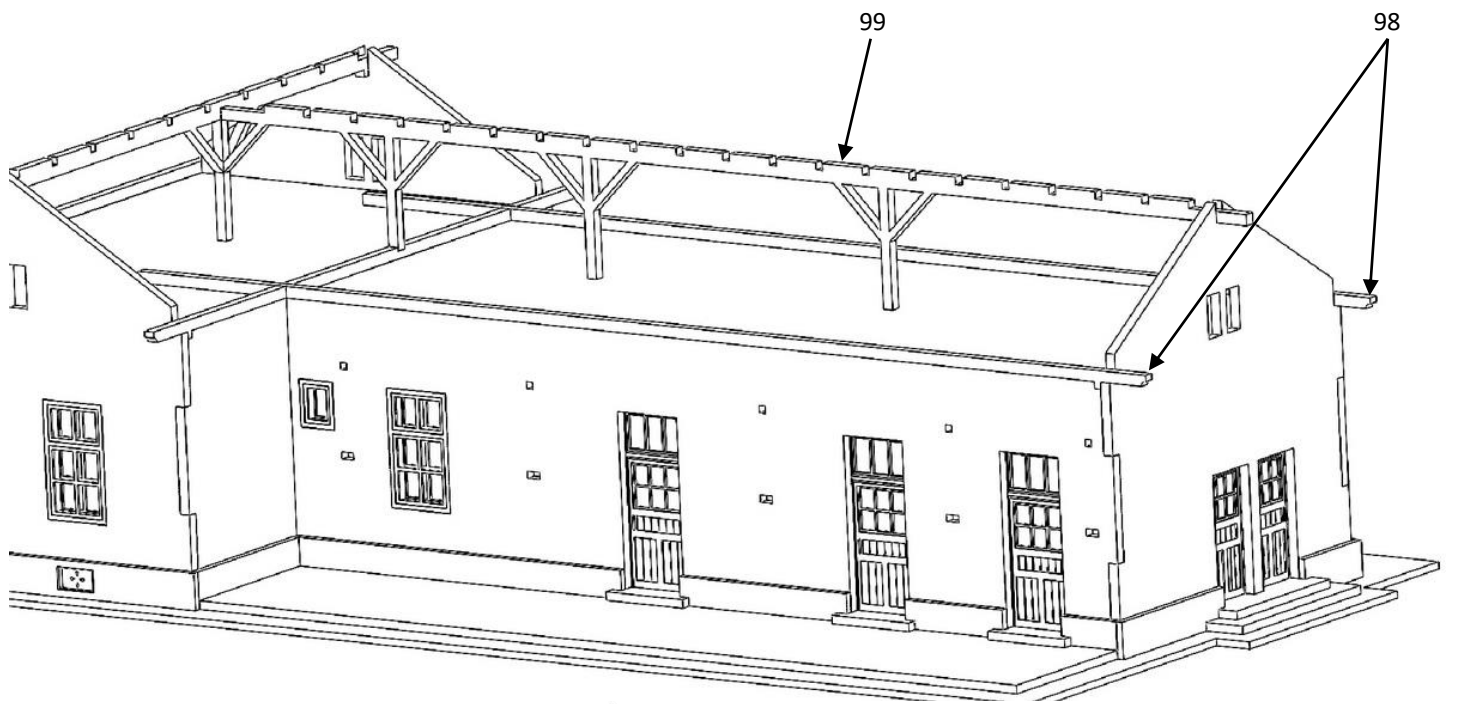

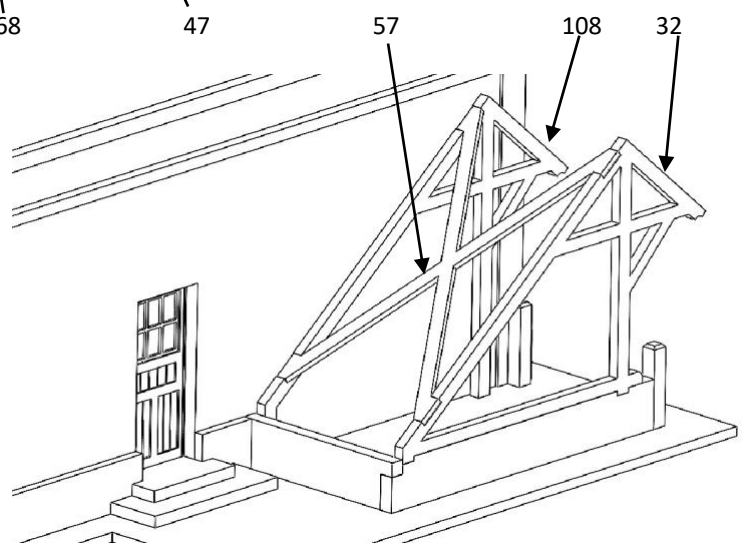
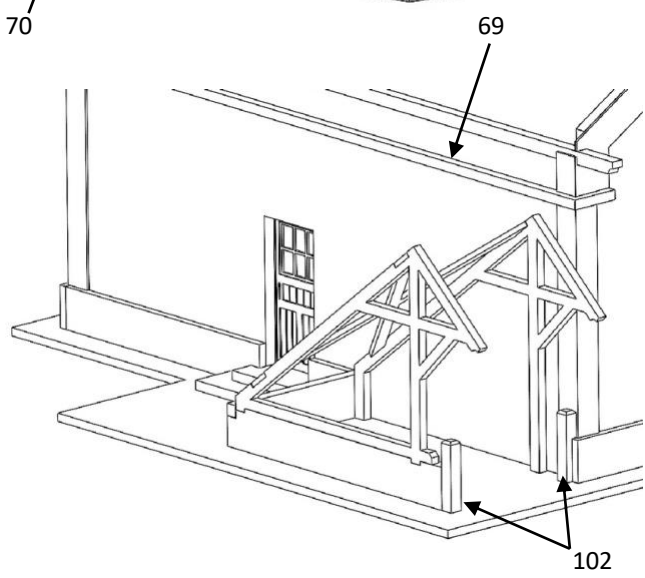
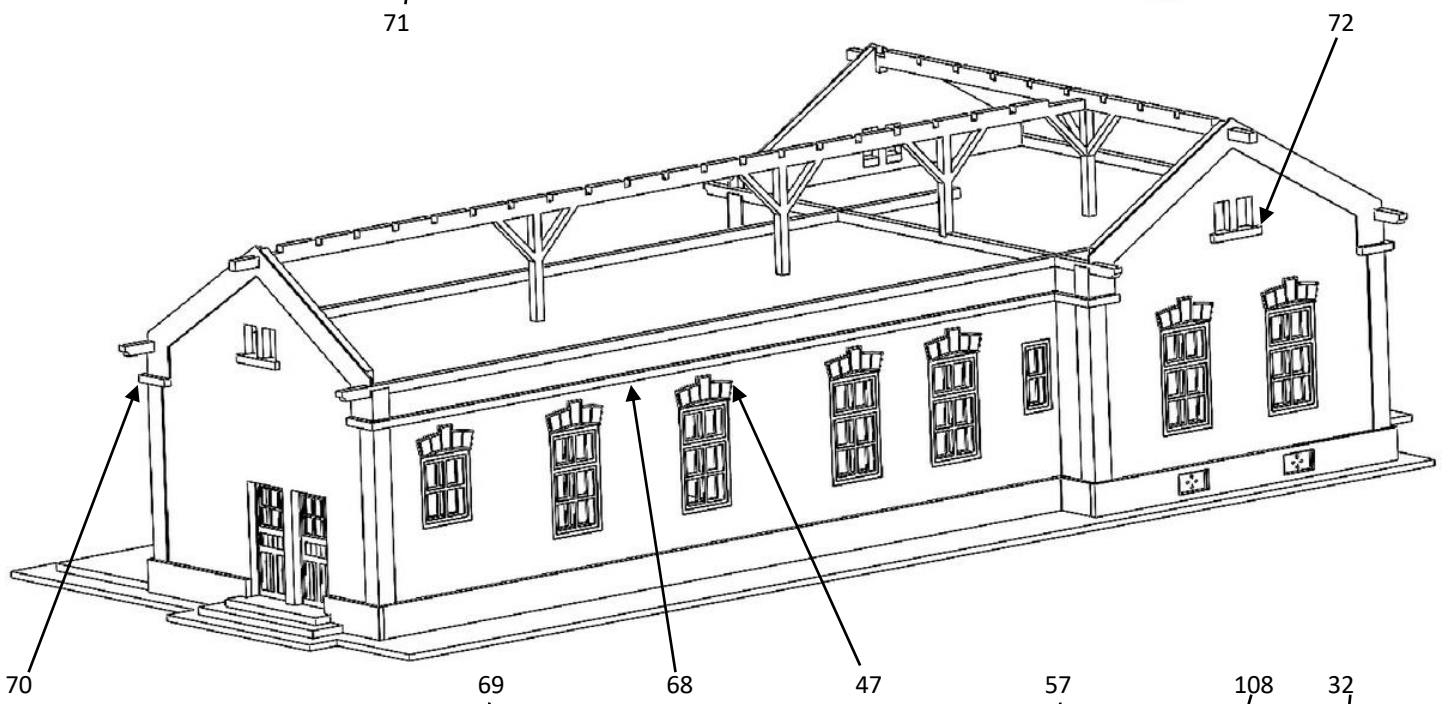
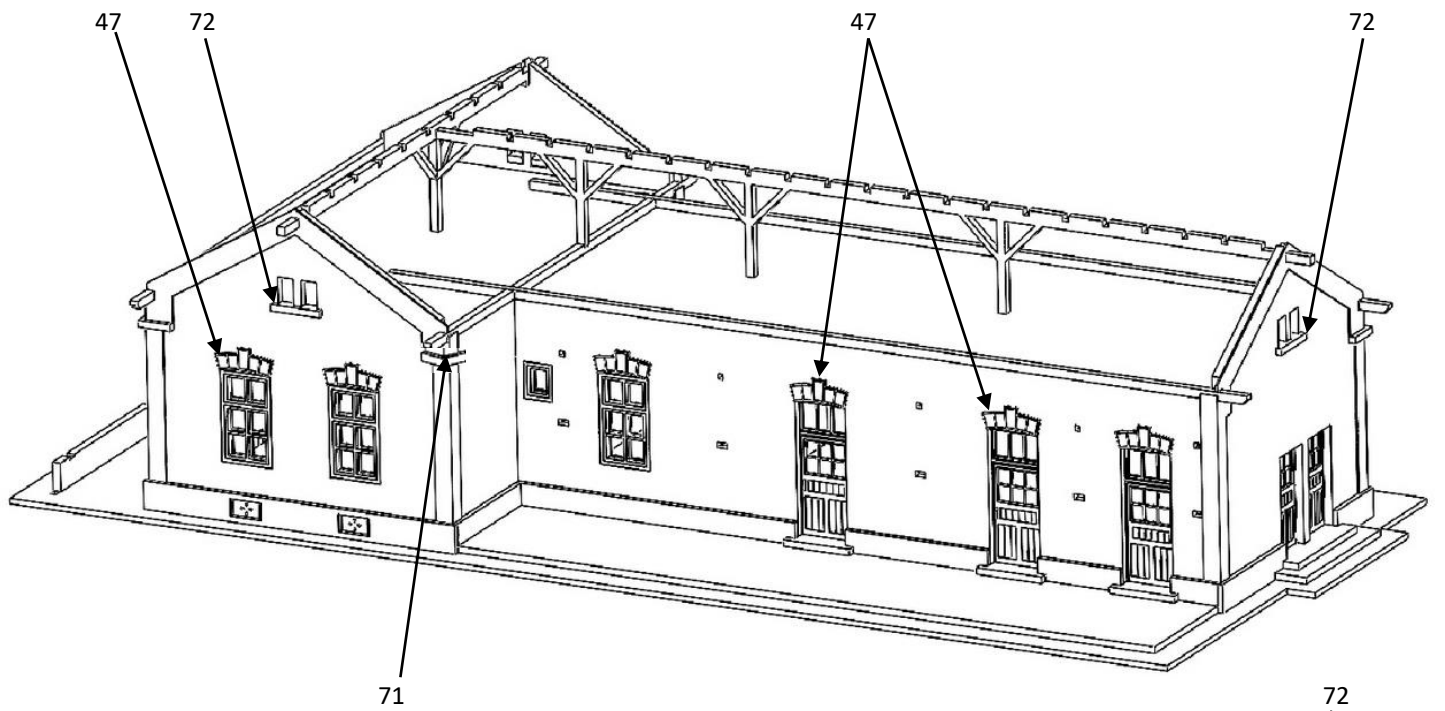

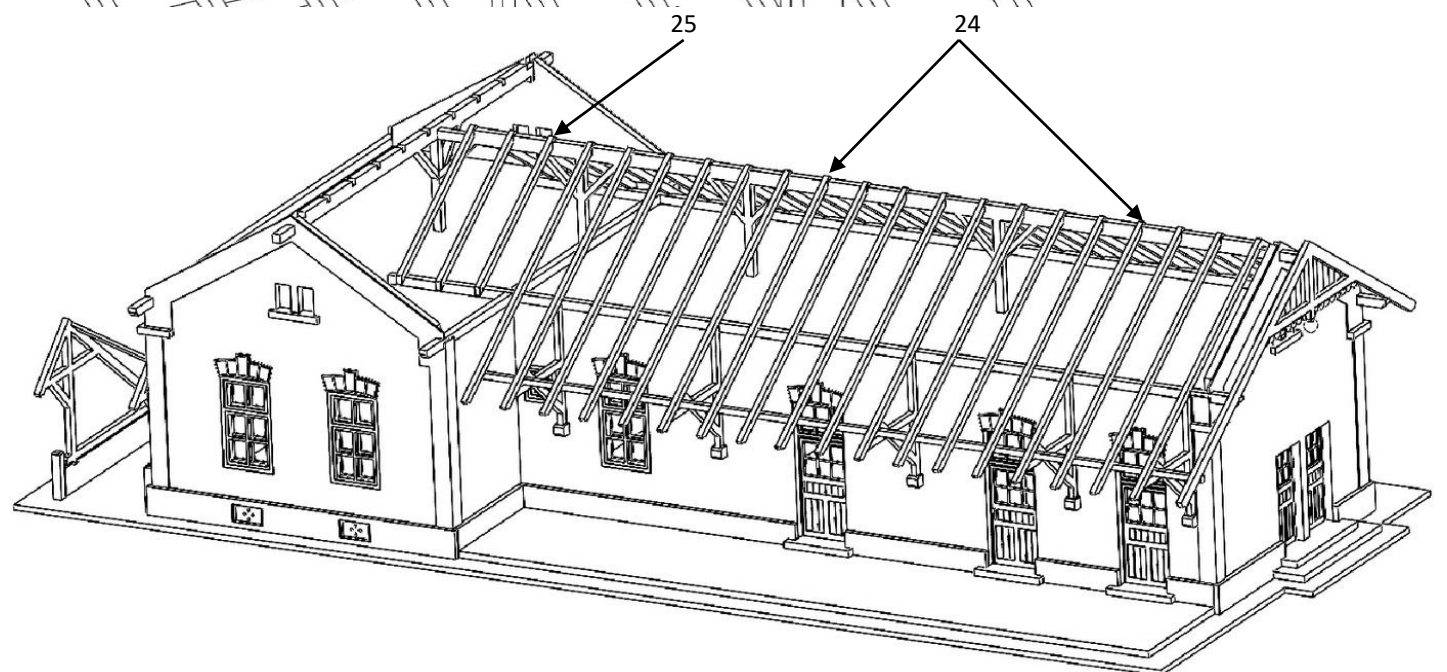
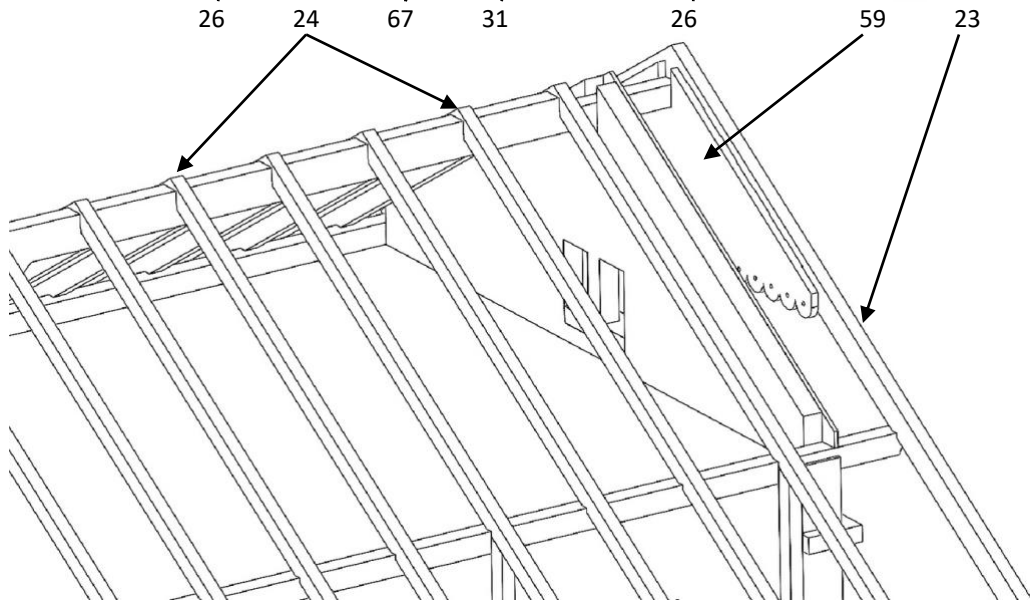
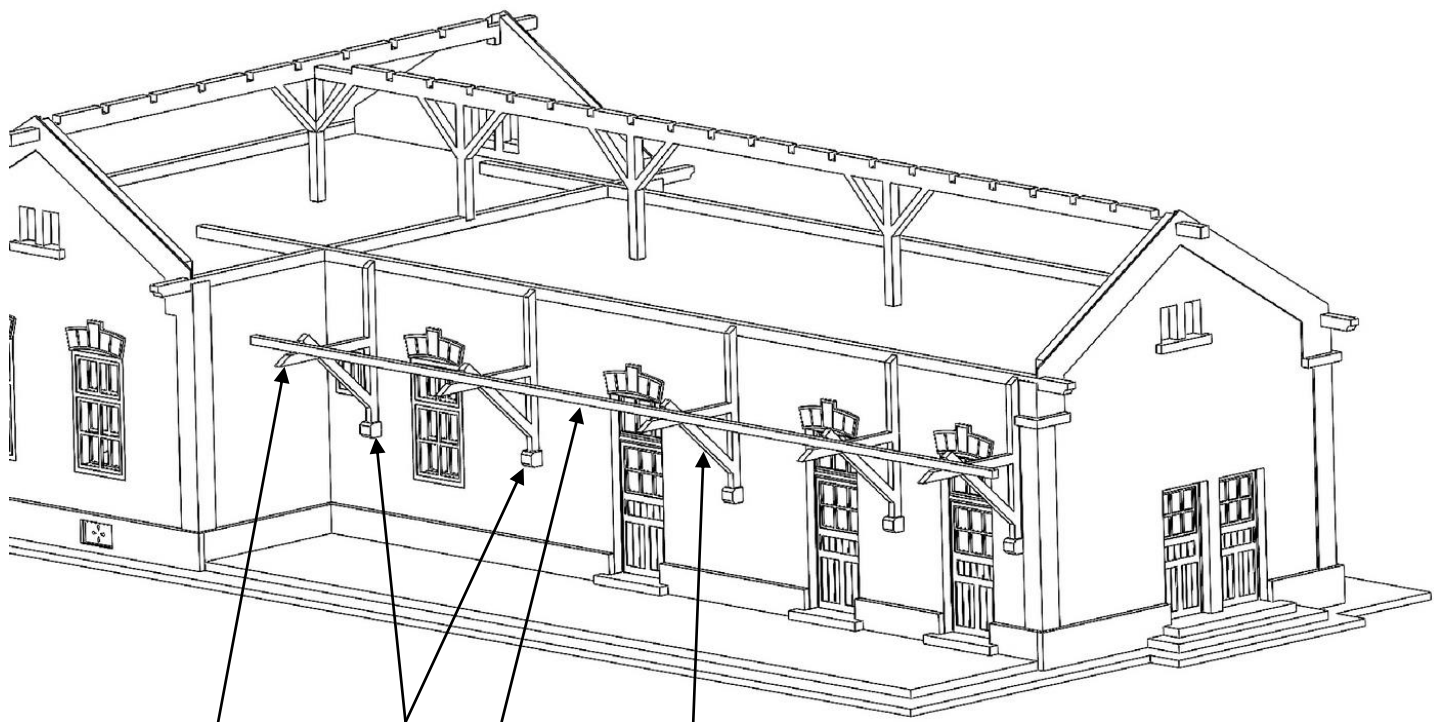

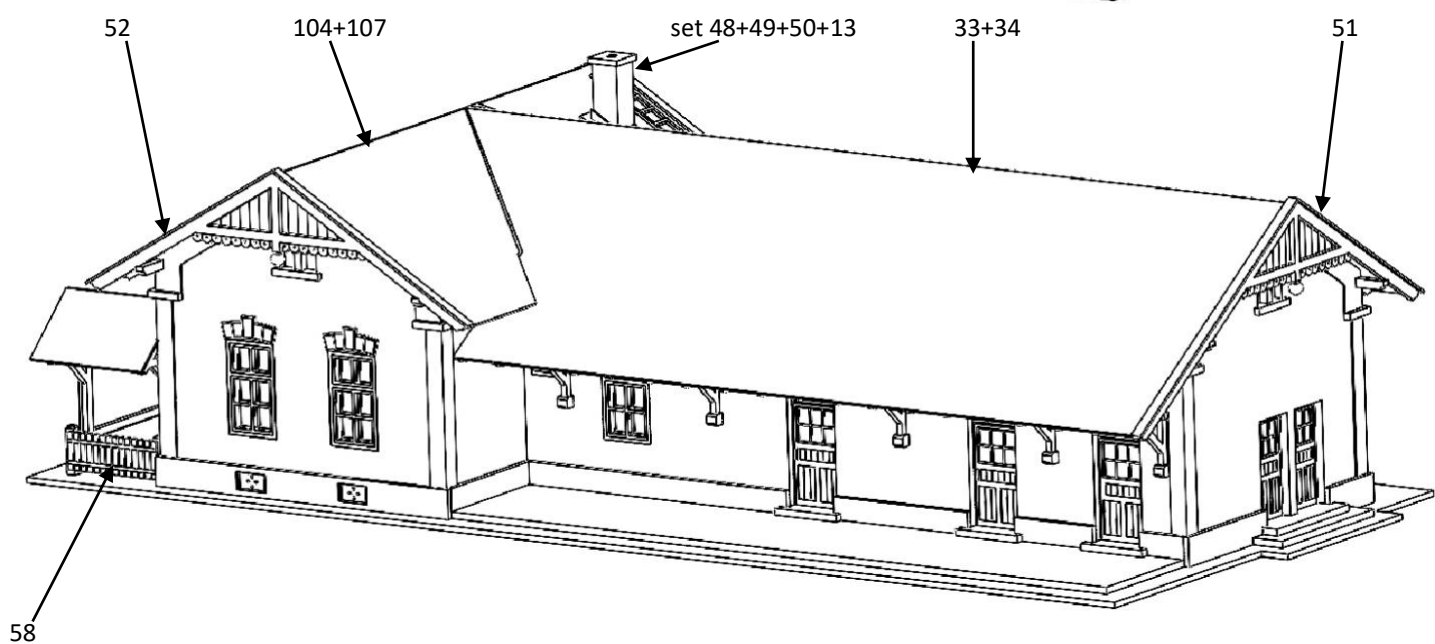
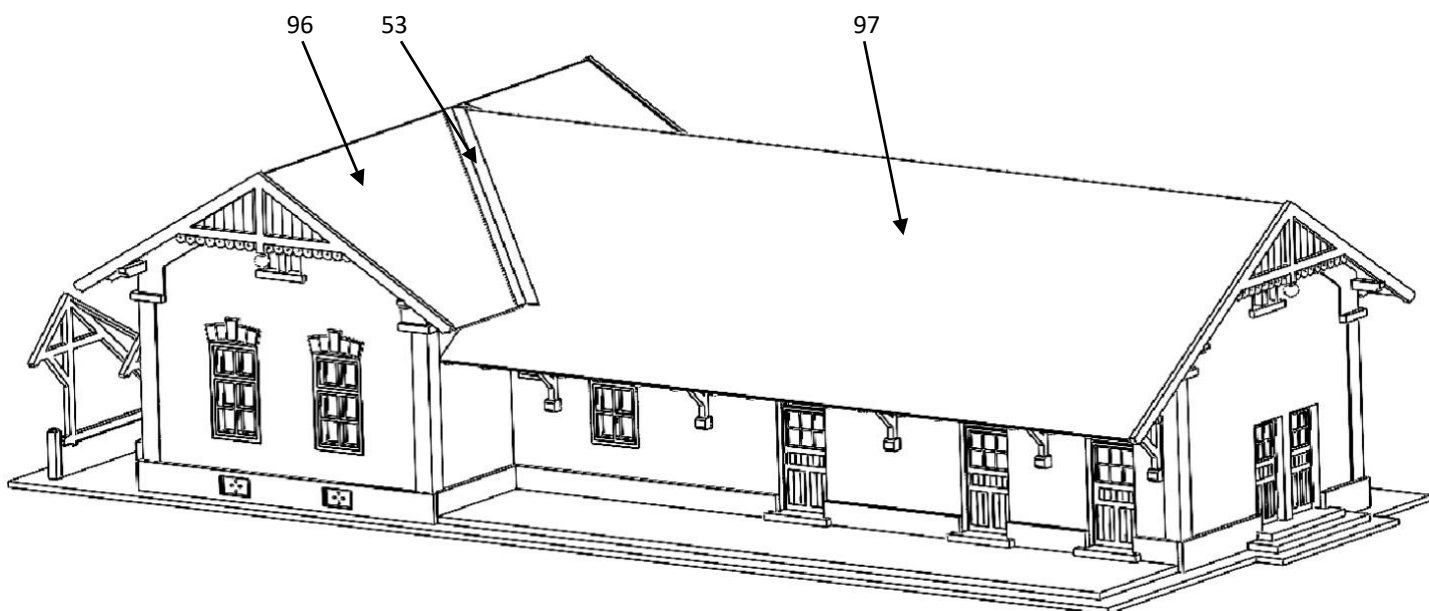
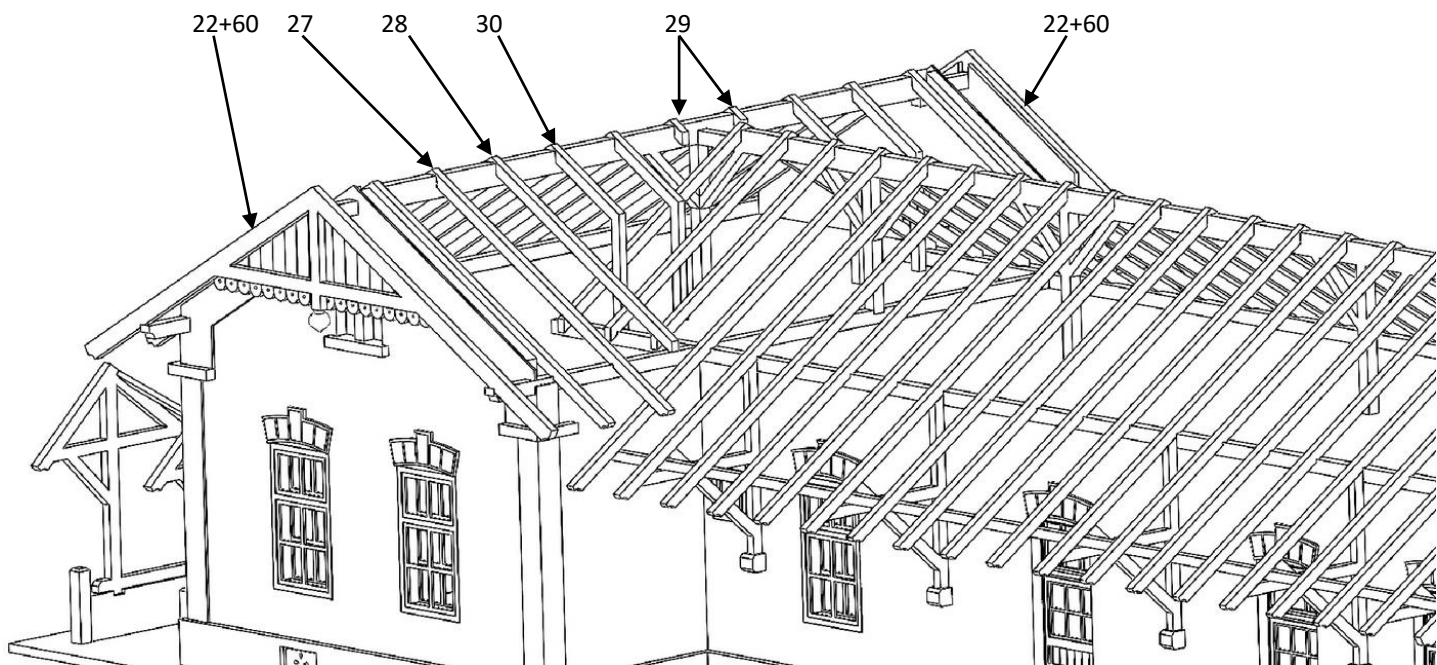

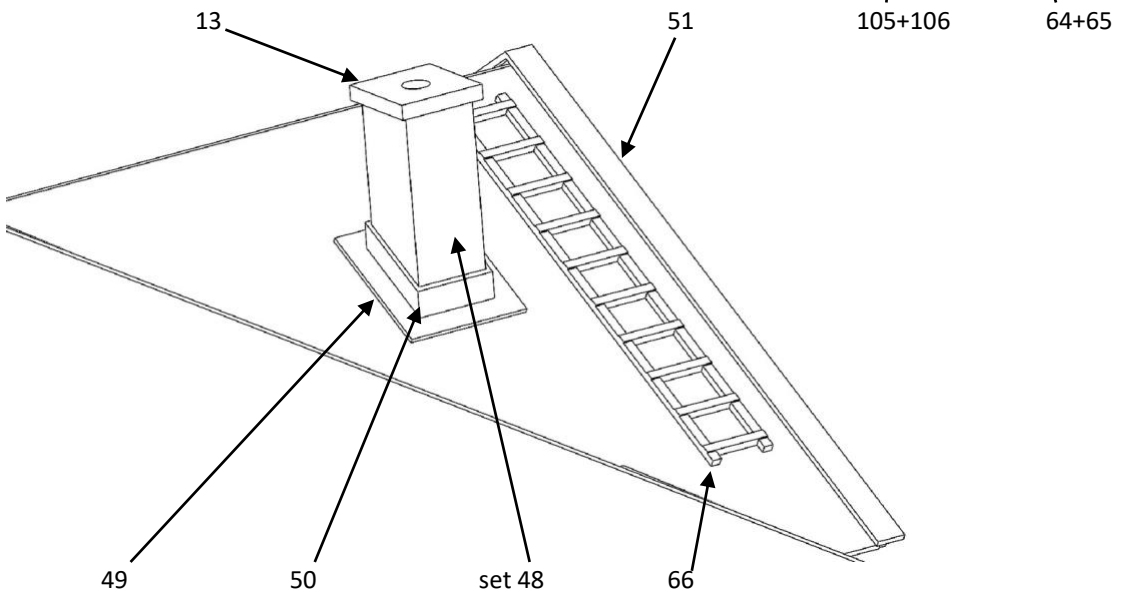
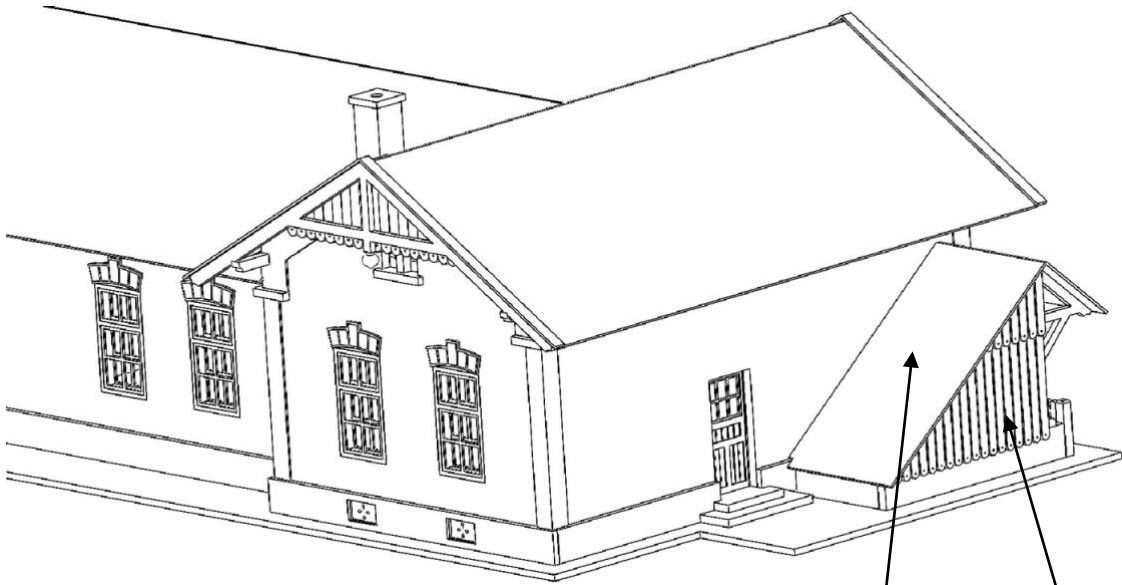
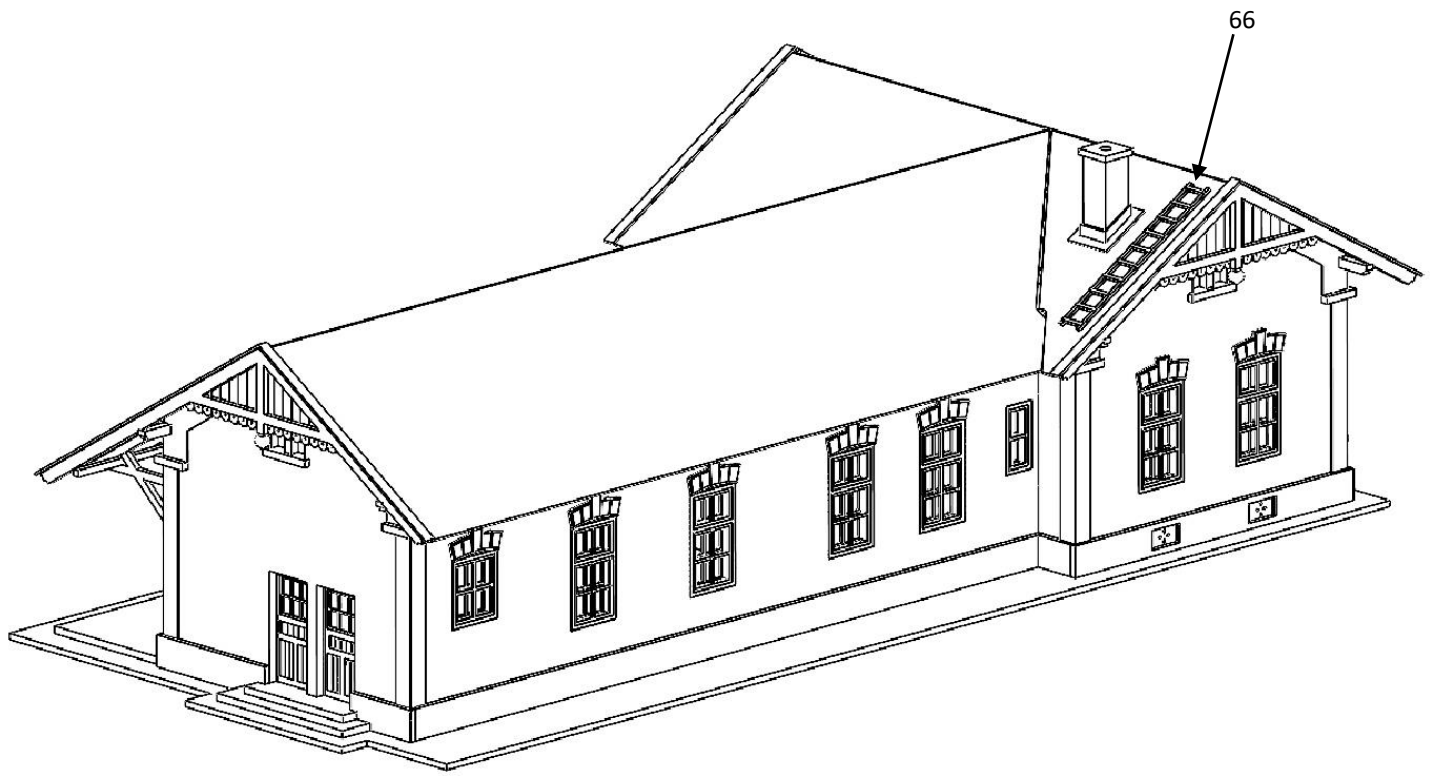

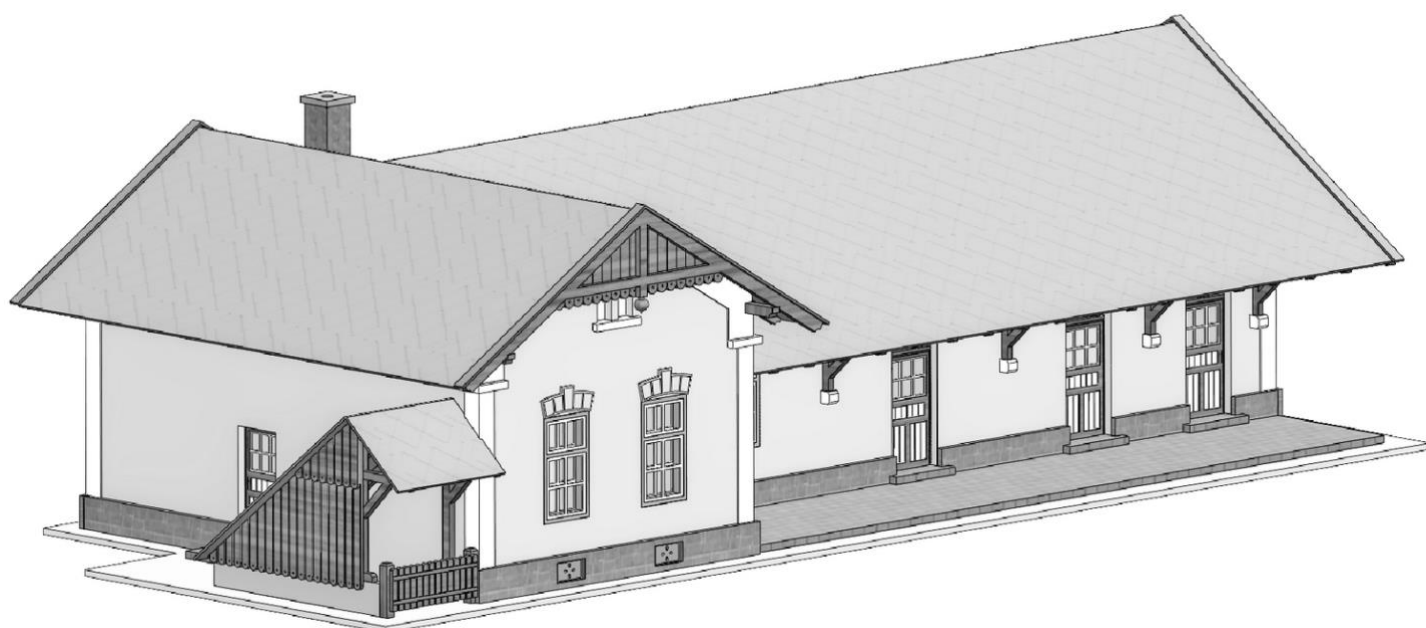
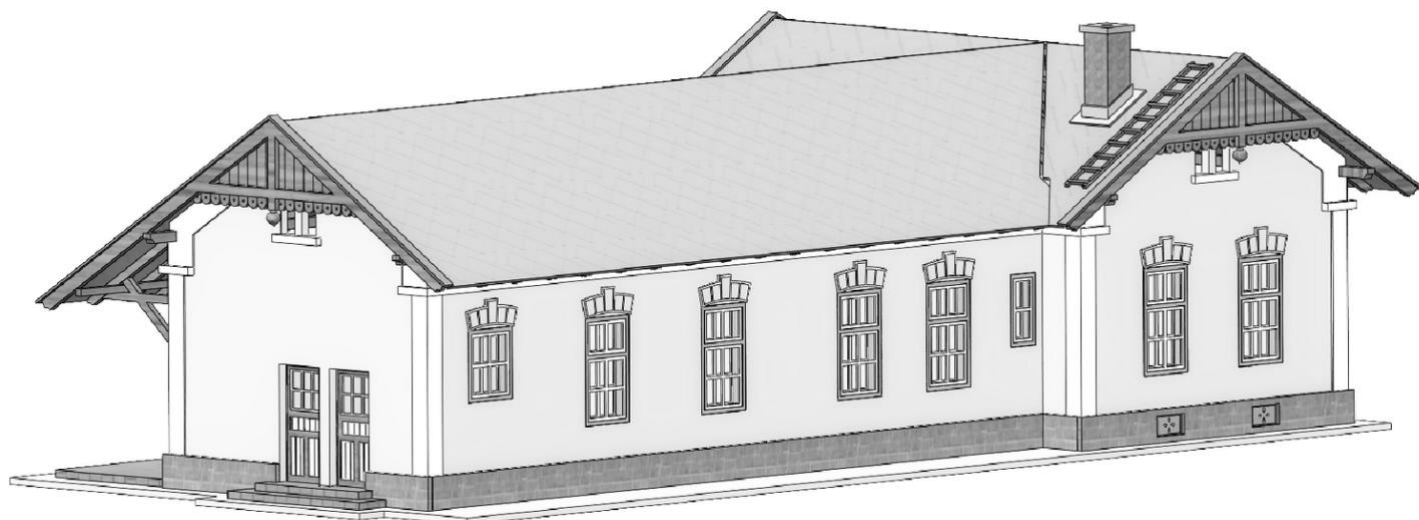

Doufám, že se vám to povedlo jak jste si předsevzali a že vám tento základní návod pomohl k bezproblémovému dokončení dle vašich představ.

Případné připomínky, poznatky, návrhy, dotazy atd. můžete posílat na: info@igramodel.cz

Další modely můžete vybírat na našich stránkách www.igramodel.cz, kde je kompletní náhled všech staveb řezaných laserem a dalších produktů a kde se také můžete zapojit do diskuzí a sami navrhnout, která další skutečná stavba by se měla ztvárnit na modelové kolejiště a tím získat i nějakou cenu.

IGRA MODEL, s.r.o.

Kotkova 19

669 02 ZNOJMO

www.igramodel.cz

info@igramodel.cz

tel.: +420 515 282 891

fax: +420 515 282 890

